

Diffuser3D

Assembly Manual Item number 3D-055-002A

Phrozen 5.5inch LCD ParaLED v2.0 early model with 3 x 5 hexagonal lens

Shipping Items

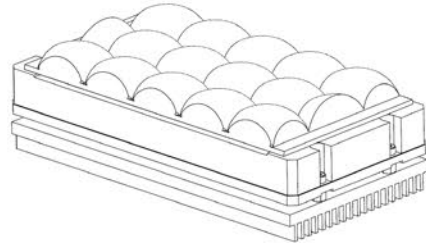
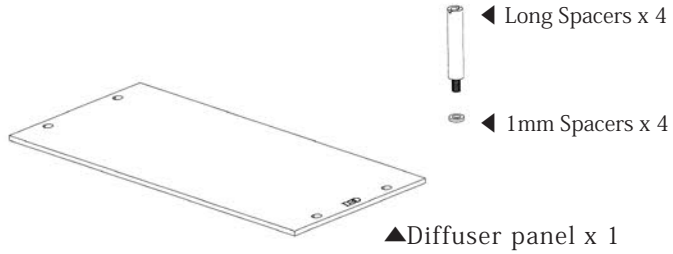

※Please bring your LED unit with you

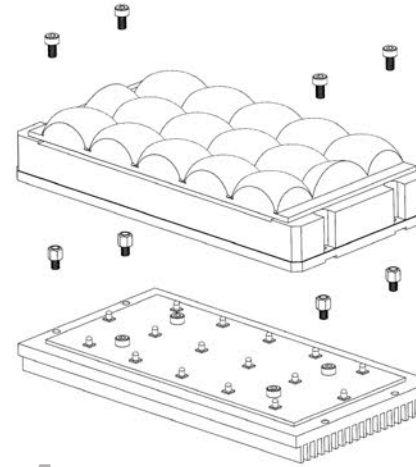

1 Remove the bolts and hexagonal spacers.

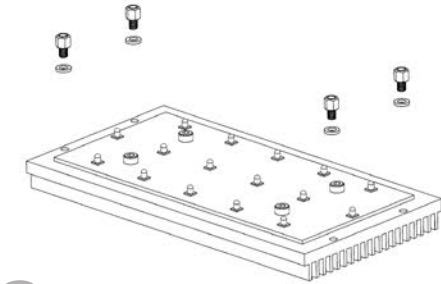

2 Attach the supplied 1mm round spacer to the hexagonal spacer.

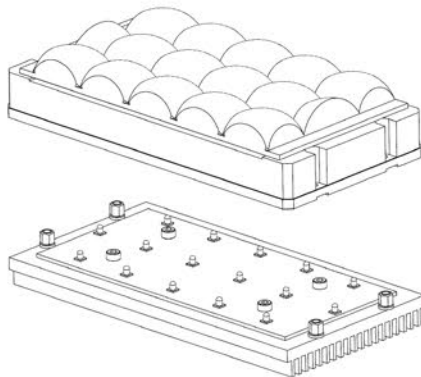

3 Shave a round shape with a rutor so that a round spacer is attached.

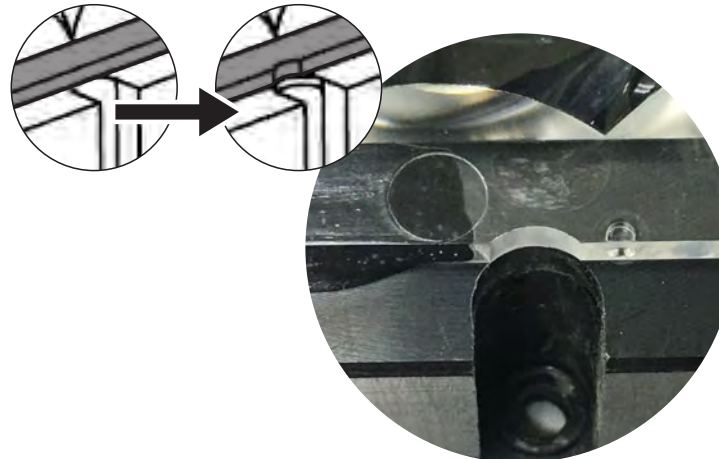

※Finished image

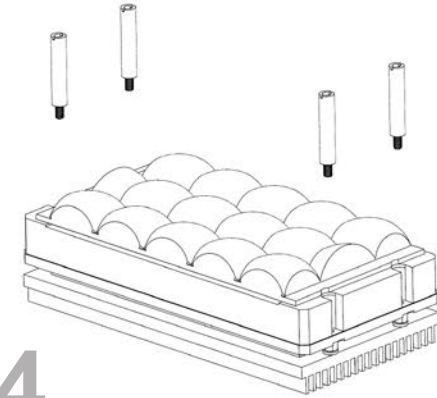

4 Install a long spacer.

Diffuser3D

Assembly Manual Item number 3D-055-002A

Phrozen 5.5inch LCD ParaLED v2.0 early model with 3 x 5 hexagonal lens

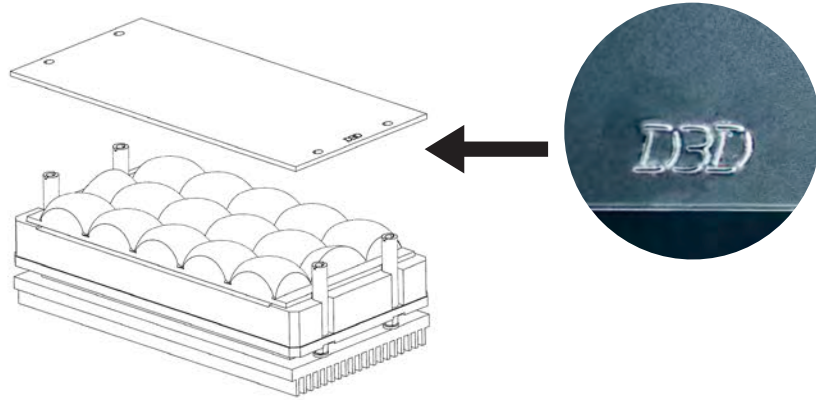

- 5 Remove the protective sticker on both sides of the diffuser and place it on the spacer so that the letters on the D3D are properly visible and the frosted side is up.

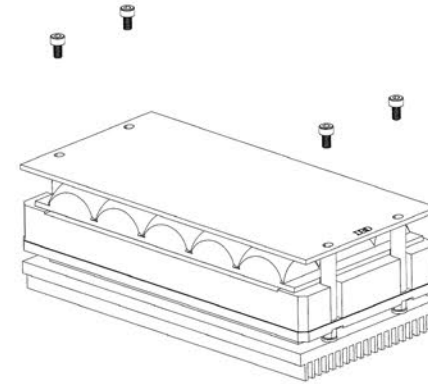

- 6 Secure with the bolts removed in (# 1)

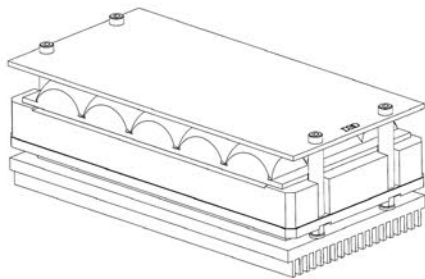

- 7 Installation is complete.